

## DIN-Signal C096MR-3,0C1-2-clip



Image is for illustration purposes only. Please refer to product description.

Part number	09 03 396 2919
Specification	DIN-Signal C096MR-3,0C1-2-clip
HARTING eCatalogue	<a href="https://b2b.harting.com/09033962919">https://b2b.harting.com/09033962919</a>

### Identification

Category	Connectors
Series	DIN 41612
Identification	Type C
Element	Male connector
Description of the contact	Angled
Features	lead-free Colour deviations and speckles permitted

### Version

Termination method	Reflow soldering termination (THR)
Connection type	Motherboard to daughtercard Extender card PCB to cable
Number of contacts	96
Contact configuration	Rows a, b and c, positions 1, 2, ... , 31, 32
Coding	Coding with loss of contacts Side coding
PCB fixing	With fixing flange With snap-in clip

### Technical characteristics

Contact rows	3
Contact spacing (termination side)	2.54 mm
Contact spacing (mating side)	2.54 mm
Rated current	2 A



Pushing Performance  
 Since 1945

## Technical characteristics

Rated current	Rated current measured at 20 °C, see derating curve for details
Clearance distance	≥1.2 mm
Creepage distance	≥1.2 mm
Insulation resistance	>10 <sup>12</sup> Ω
Contact resistance	≤20 mΩ
Limiting temperature	-55 ... +125 °C (during reflow soldering max. +240 °C for 15 s)
Insertion and withdrawal force	≤90 N
Performance level	1 acc. to IEC 60603-2
Mating cycles	≥500
Test voltage U <sub>r.m.s.</sub>	1 kV
Isolation group	II (400 ≤ CTI < 600)
PCB thickness	1.6 mm ±0.2
Hot plugging	No

## Material properties

Material (insert)	Thermoplastic resin, glass-fibre filled
Colour (insert)	Beige
Material (contacts)	Copper alloy
Surface (contacts)	Noble metal over Ni Mating side Sn over Ni Termination side
Material flammability class acc. to UL 94	V-0
RoHS	compliant
ELV status	compliant
China RoHS	e
REACH Annex XVII substances	Not contained
REACH ANNEX XIV substances	Not contained
REACH SVHC substances	Not contained
California Proposition 65 substances	Yes
California Proposition 65 substances	Lead Nickel
Requirement set with Hazard Levels	R26

## Specifications and approvals

Specifications	IEC 60603-2
----------------	-------------



Pushing Performance  
Since 1945

## Specifications and approvals

UL / CSA UL 1977 ECBT2.E102079  
CSA-C22.2 No. 182.3 ECBT8.E102079

Railway classification F4/I3 acc. to NFF 16-101/102

## Commercial data

Packaging size	20
Net weight	15.45 g
Country of origin	Germany
European customs tariff number	85366990
GTIN	5713140196247
eCl@ss	27460201 PCB connector (board connector)

## Current carrying capacity

The current carrying capacity of the connectors is limited by the thermal load capability of the contact element material including the connections and the insulating parts. The derating curve is therefore valid for currents which flow constantly (non-intermittent) through each contact element of the connector evenly, without exceeding the allowed maximum temperature.

Measuring and testing techniques acc. to IEC 60512-5-2

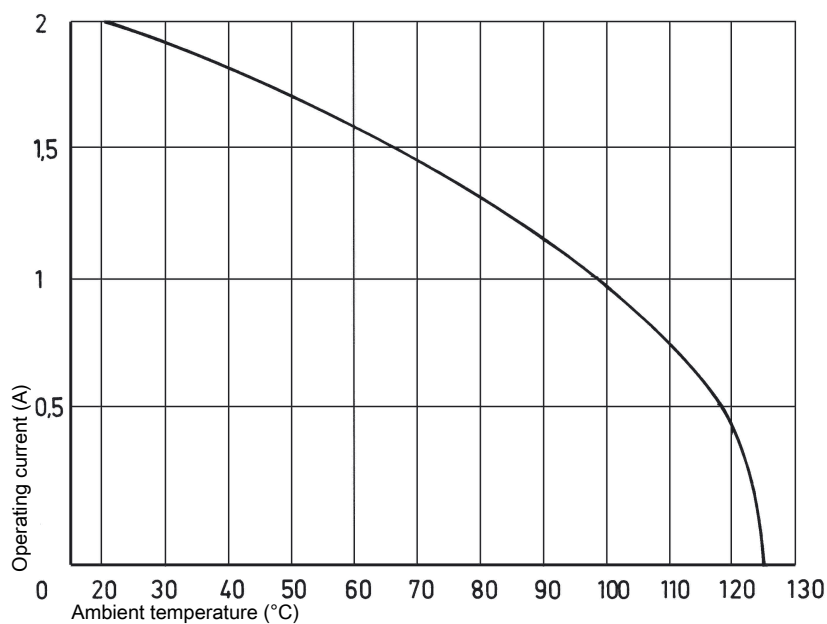

### Side coding (without loss of contact)



To avoid cross-plugging of adjacent connectors a coding system is required. This coding system is an integral part of both male and female connectors. A comb with 12 coding pins, which is supplied under part number 09 02 000 9928, allows over 900 coding variations. The pins are to be locked into the male and female connectors. These coding bars can be screwed on the top side of angled male and female connectors. They are alternatives to the male and female connectors with pre-assembled or splashed coding bars. As far as available we recommend the connectors with pre-assembled or splashed coding bar.

### Coding with loss of contacts

To avoid cross-plugging of adjacent connectors a coding system is required. The coding is achieved by means of a code pin which is inserted into the selected chamber of the female connector (the contact cavity must be filled with a female contact!).

The opposite male contact must be removed with the help of the specially designed tool. It's recommended to use a number of code pins in relation to the total number of contacts per connector: 3 pins for 64 contacts, 7 pins for 160 contacts

Coding pin 09 02 000 9901

Removal tool for male contacts 09 99 000 0133

### Cross section of solder termination

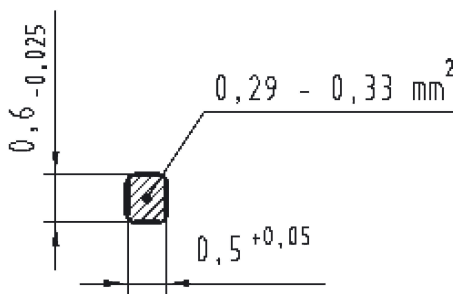

## Quantity of solder paste

Before the components are assembled, solder paste must be applied to all the solder pads (for connecting surface-mount components) and the plated through holes. To ensure that the plated through holes are completely filled, significantly more solder paste must be applied than traditional solder pads on the pcb surface. There are numerous calculation methods available which are complicated to apply. The following rule of thumb has proved valuable in practice.

Required volume of paste = 2 (Volume of plated through hole - Volume of the connector termination in the hole)

Comment: the multiplier "2" compensates for solder paste shrinkage during soldering. For this purpose, it was assumed that 50% of the paste consists of the actual solder, the other 50% being soldering aids.

## Soldering instructions

THR (ThroughHoleReflow) connectors are designed to be used in a reflow oven together with other SMD (SurfaceMountDevice) components. In the process, called as well "Pin in Hole Intrusive Reflow", the connectors are inserted into plated through holes in a comparable way to conventional component mounting. All other components can be assembled on the pcb surface.

The length of the connector contacts should be such that they protrude by no more than 1.5 millimetres after insertion to the pcb. Each contact collects solder on its tip as it penetrates the solder paster in the hole. So if the contact is too long, this solder would no longer be able to reflow back into the plated through hole by capillary action during the soldering process, therefore the quality of the soldered connection would suffer as a result.

## Mating conditions

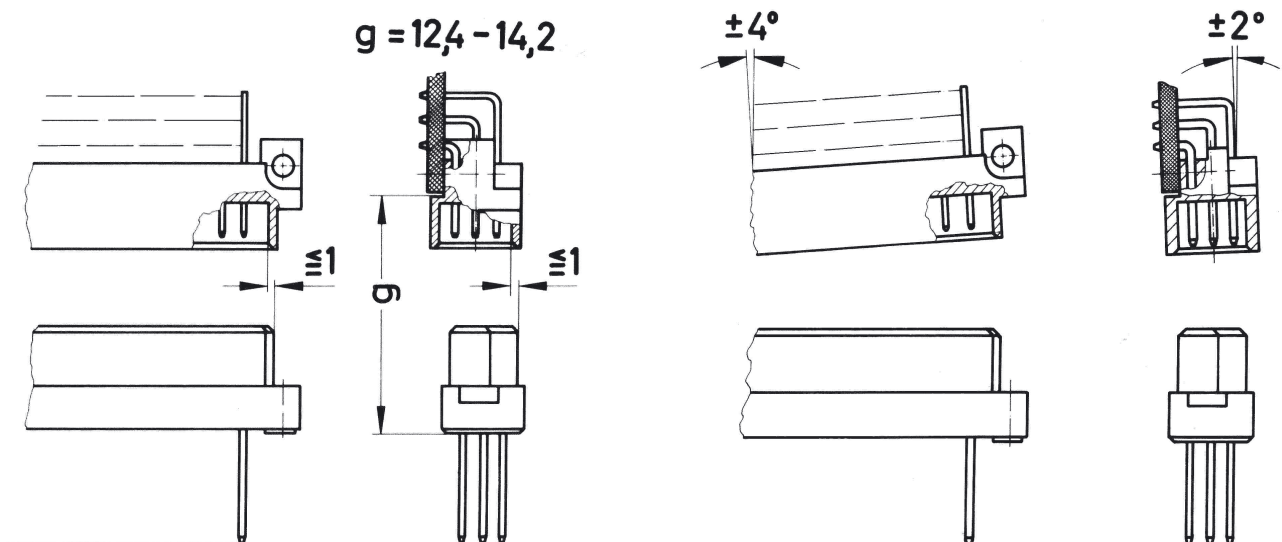

To ensure reliable connections and prevent unnecessary damage, please refer to the application data diagrams. These recommendations are set out in IEC 60603-2.

The connectors should not be coupled and decoupled under electrical load.